

VERSIONE IN MARCIA

VERSIONE GIORNO

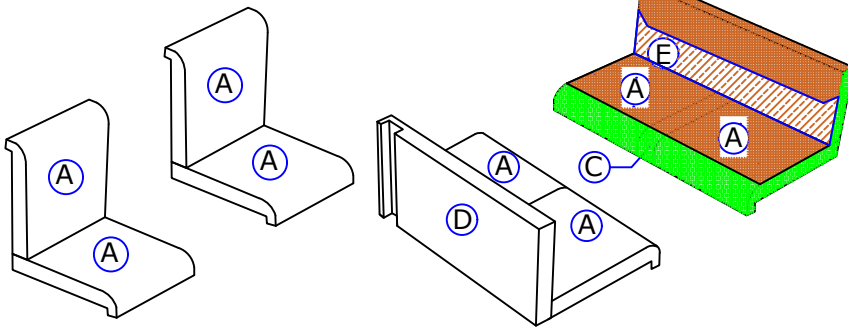

LEGENDA	
TIPO	TESSUTO
	Elettra col.6
	Stone col.4
	Stone col.1

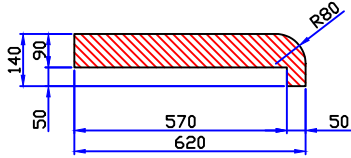

Q.ta n°4

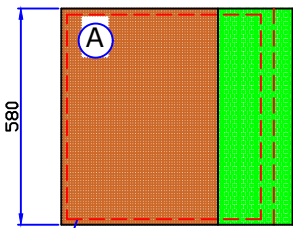

Inserire tavola

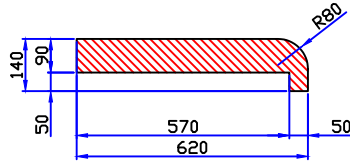

Q.ta n°2

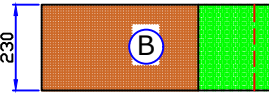

Q.ta n°1

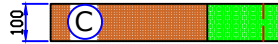

Vestitino per  
spalliera  
struttura  
cinture  
Q.ta n°2

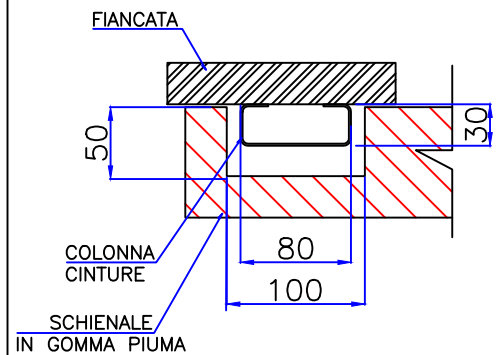
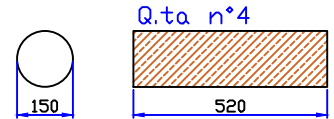
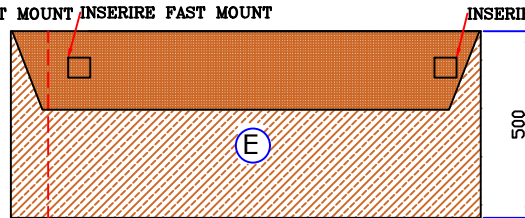
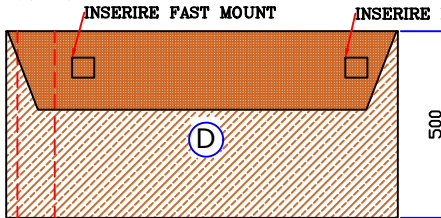
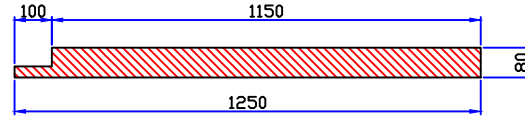
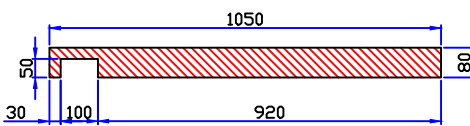
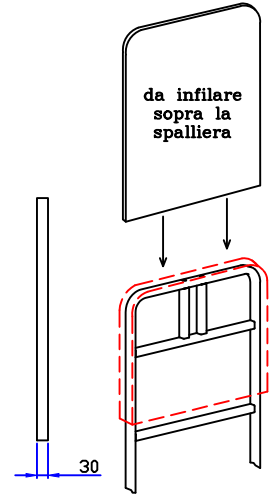
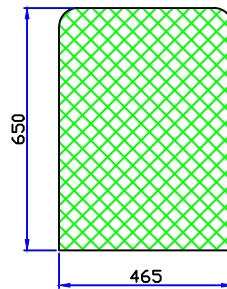

**LCAMP**   
SEDE Via Piemonte n°3  
53036 Poggibonisi SIENA ITALY

Denominazione	Cuscini Seal 66 - 99	Codice	1TAP090738
Caratteristiche gommapiuma	SCHIENALI-POGGIATESTA Densita'21 Kg/m <sup>3</sup> SEDUTE-MATERASSI Densita'25 Kg/m <sup>3</sup>	Codice lavorazione	-----

TOLLERANZE DI MASSIMA Grado di precisione medio UNI 5307	PAG 1 di 1	Produzione	Meccanica	NOTE	Le dimensioni sono riferite al cuscino finito	Rev	00	Data	27-03-2020
Disegnato A.PINZUTI	Data 27-03-2020	2020-2021	FIAT						
Approvato A.PINZUTI	Data 27-03-2020	Rev		MODIFICA				DATA	ESEGUITA

I dati e le informazioni contenuti o ricavabili da questo disegno sono di esclusiva proprieta' della Luano Camp S.r.l.  
Ogni riproduzione totale o parziale e' vietata senza l'autorizzazione scritta della ditta Luano Camp S.r.l.